

Lecture 2. Part 1. Subrecoil colling and Lévy statistics

1. VSCPT in a nustshell

- Physical idea: trapping state, velocity selective if counter propagating lasers
- Inhomogeneous random walk in p space; accumulation around $p=0$; Maxwell demon.
- Necessity to quantize motion : closed family of states $F(p)$, under interaction with the lasers; random walk in the space of families; accumulation in the family $p=0$.

Open questions:

- What is the width of the peak around $p=0$?
- How does it evolve with time?
- Steady state?
- How many atoms are accumulated?

A hand waving argument: rate of fluorescence as p^2 ; $\delta p \propto 1/\sqrt{\theta}$ with θ interaction time. Can we be more quantitative?

Yes:

- Generalized optical Bloch equations
- Quantum Monte Carlo
- Lévy statistics

2. Generalized Optical Bloch Equations

2.1 Optical Bloch equations

Hamiltonian evolution plus relaxation

2.2 GOBE

Hamiltonian evolution within each family

Redistribution between various families due to spontaneous emission

2.3 Results

Width decreases as $\delta p \propto 1/\sqrt{\theta}$ as expected.

Efficiency quite good.

But saturates the power of computer because long calculation, and discretization finer and finer.

3. Quantum Monte-Carlo and delay function

A more efficient way of doing numerics.

Confirms the width decrease as $\delta p \propto 1/\sqrt{\theta}$ as well as the efficiency.

Confirms the picture of atoms trapped a long time close to $p = 0$.

Suggests to look at the statistics of the trapping times.

4. A Lévy flights approach

Law of probability of trapping times, for a uniform sprinkling: long tails

Non standard statistics; no average of trapping time; long trapping times play an important role

In a sum of trapping times, Lévy sum: non ergodic; increases faster than the number of events; the reason is that when one tries more, there is more chance to have one event with

a longer trapping time; in fact, in a given interval, the sum is dominated by the longer trapping time.

Allows complete calculation. In agreement with quantum optics, in the asymptotic regime. Gives predictions in a regime where quantum optics cannot give results: asymptotic; higher dimensions.

For instance, role of friction force, important in 2D and crucial in 3D. Role of the power law.

Has allowed to improve Raman cooling in 1D; to design experiments for cooling in 2D and 3D. Checked experimentally. Spectacular results.

5. Conclusion

It has been possible to break a whole series of limits:

- Doppler limit
- Recoil limits
- Optical Earnshaw theorem

Going beyond the traditional methods (Optical Bloch Equations, density matrix approach) is very fruitful. Quantum Monte Carlo yields an image, and images lead to different points of views and insights. Using statistical methods has allowed us to answer questions without a solution in standard quantum optics.

Subrecoil cooling and Lévy statistics

→ Non ergodic cooling

→ Cooling without limits

F. Bardou, J. P. Bouchaud, A. A.

C. C. - T.

Experiments

A. A., C. C. - T.

N. Vansteenkiste, R. Kaiser, E. Arimondo,
O. Emile, F. Bardou, J. Lawall, C. Gerz,
C. Westbrook, S. Kulin, B. Saubamea,
E. Rasel, M. Leduc

The recoil "limit"

Standard cooling (Doppler, Sisyphus)

→ Steady state: competition between friction cooling and heating due to the randomness of spontaneous emission

Uncontrollable recoil:



$$V_R = \frac{\hbar k}{M}$$

$$\text{He}^*: V_R = 9.2 \text{ cm/s}$$

$$\text{Cs}: V_R = 0.3 \text{ cm/s}$$

→ Steady state temperature $> T_R$

$$T_R = \frac{1}{k_B} \frac{\hbar^2 k^2}{M}$$

$$\text{He}^*: 4 \mu\text{K}$$

$$\text{Cs}: 0.2 \mu\text{K}$$

Ultimate limit?

$T \gg 10 T_R$ observed in Sisyphus cooling

A completely different
laser cooling method:

Velocity Selective Coherent

Population Trapping (ENS, 88)

A related method: Raman cooling
(Chu, Kasevitch) (Stanford, 92)

Coherent Population Trapping

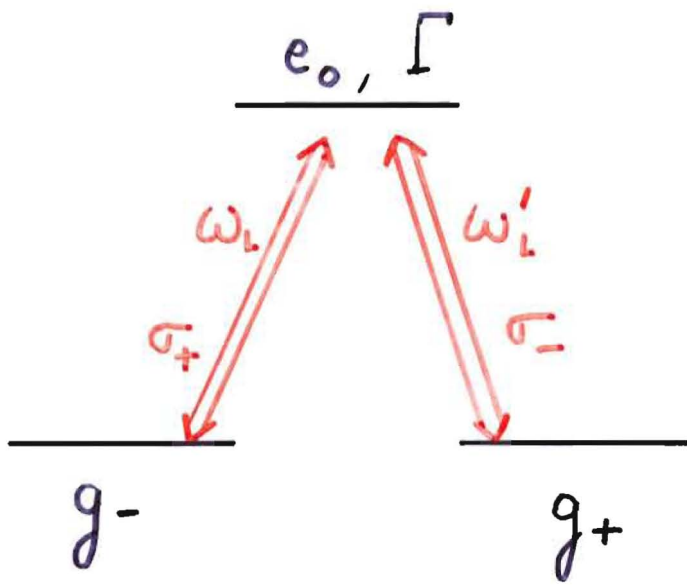

3-level Λ system

g_- and g_+ : stable.

e_0 : width Γ

Observation (Gozzini et al. 76)

- if $\delta = \omega'_L - \omega_L = 0$, no. fluorescence
(Dark resonance)
- width: damping rate of $\sqrt{g_+ g_-}$
i.e. narrower than Γ

Theory (Arimondo & Orriols, 76)

- steady state of the O.B.E.:

$$\sigma_{ee} = 0$$

$$\sqrt{g_- g_+} = -\frac{1}{2}$$

Interpretation

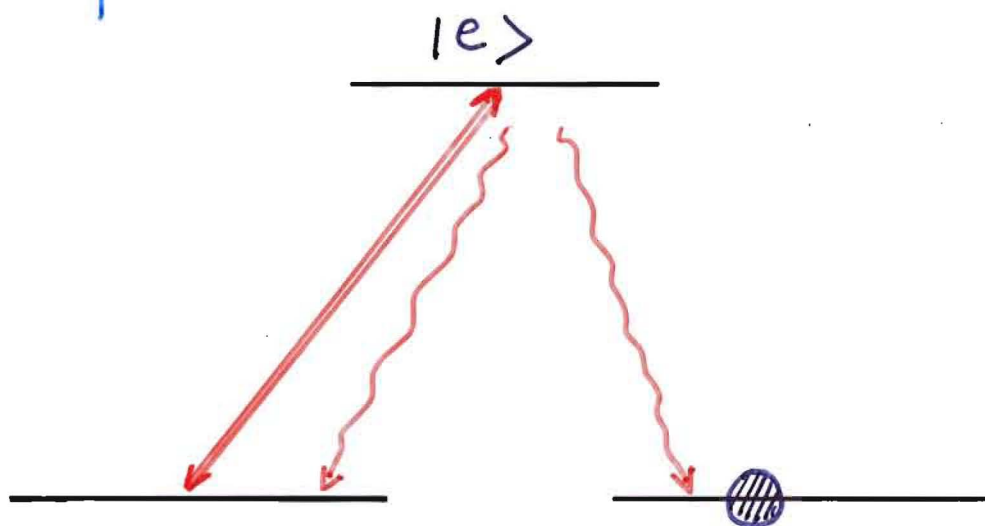

$$|\psi_c\rangle = \frac{1}{\sqrt{2}}(|g_{-}\rangle + |g_{+}\rangle)$$

$$|\psi_{nc}\rangle = \frac{1}{\sqrt{2}}(|g_{-}\rangle - |g_{+}\rangle)$$

$|\psi_{nc}\rangle$ is not coupled to $|e\rangle$

$$\langle e | \hat{D} \cdot (\vec{E}_L + \vec{E}_{L'}) | \psi_{nc} \rangle = 0 \quad \left. \begin{array}{l} \text{quantum} \\ \text{interference} \end{array} \right\}$$

Optical pumping (accumulation) into $|\psi_{nc}\rangle$
Resonant effect

Velocity Selective Coherent Population Trapping for counterpropagating lasers beams

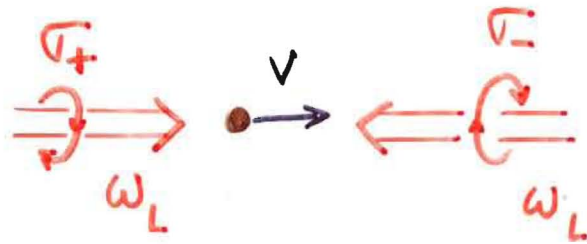

. For $v \neq 0$ the condition $\delta = 0$ is not fulfilled (Doppler effect)

→ $|\Psi_{Nc}\rangle$ is a trapping state only when $v = 0$

→ Diffusion in the momentum space until the atom is optically pumped into $|\Psi_{Nc}\rangle$ at $v = 0$

→ Accumulation of atoms into the zero velocity class

Accumulation in a velocity class narrower than $\frac{\hbar k}{M}$ possible?

But... if $\Delta p < \hbar k$

$$\Delta x \geq \frac{\hbar}{2\Delta p} > \frac{1}{2k} = \frac{\lambda_{\text{opt}}}{4\pi}$$

The atomic wavepacket is no longer small compared to the wavelength of the light.

The motion of the atom must be described by quantum mechanics

→ The principle of VSCPT can be generalized: accumulation in non-coupled states $|\Psi_{nc}(p)\rangle$ with $p \approx 0$.

Quantum treatment of the motion

closed family of states

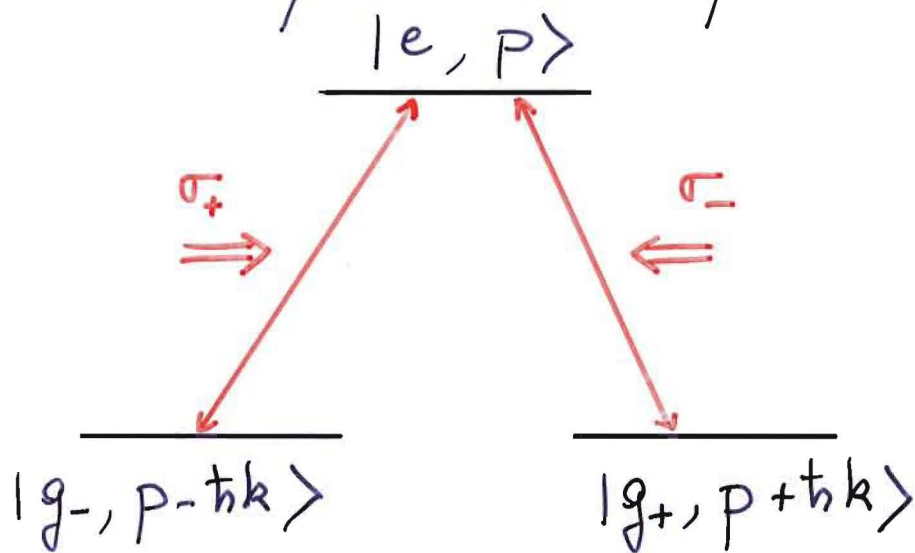

coupled by interaction with the lasers

New basis:

$$|\Psi_{nc}(p)\rangle = \frac{1}{\sqrt{2}} (|g_-, p - \hbar k\rangle - |g_+, p + \hbar k\rangle)$$

$$|\Psi_c(p)\rangle = \quad \quad \quad + \quad \quad \quad$$

$|\Psi_{nc}(p)\rangle$ is not coupled to $|e\rangle$ by the lasers, but it evolves into

$|\Psi_c(p)\rangle$ which is coupled $\left(\frac{\hat{p}^2}{2M}\right)$

except if $p=0 \Rightarrow$ accumulation into $|\Psi_{nc}(p=0)\rangle$

Non-coupled and coupled states

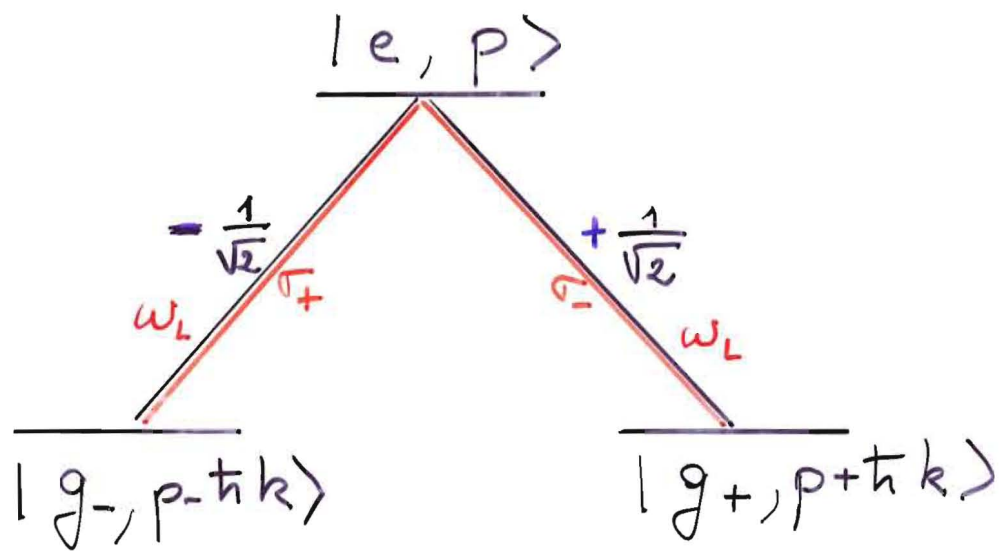

$$|\Psi_{nc}(p)\rangle = \frac{1}{\sqrt{2}} \{ |g_-, p - \hbar k\rangle + |g_+, p + \hbar k\rangle \}$$

is not coupled to $|e, p\rangle$ because of destructive interference between transition amplitudes

→ No (direct) fluorescence

$$|\Psi_c(p)\rangle = \frac{1}{\sqrt{2}} \{ |g_-, p - \hbar k\rangle - |g_+, p + \hbar k\rangle \}$$

is strongly coupled to $|e, p\rangle$

→ Strong fluorescence (photons scattered out of the laser modes)

Velocity Selective Coherent Population Trapping

(ENS, 1988)

$$|\Psi_{NC}(P)\rangle = \frac{1}{\sqrt{2}} \{ |g_-, P - \hbar k\rangle + |g_+, P + \hbar k\rangle \}$$

is not an eigenstate of

$$\hat{H}_{At} = \hat{H}_{int} + \frac{\hat{P}^2}{2M}$$

$$\langle \Psi_c(P) | \frac{\hat{P}^2}{2M} | \Psi_{NC}(P) \rangle = -\hbar k \frac{P}{M}$$

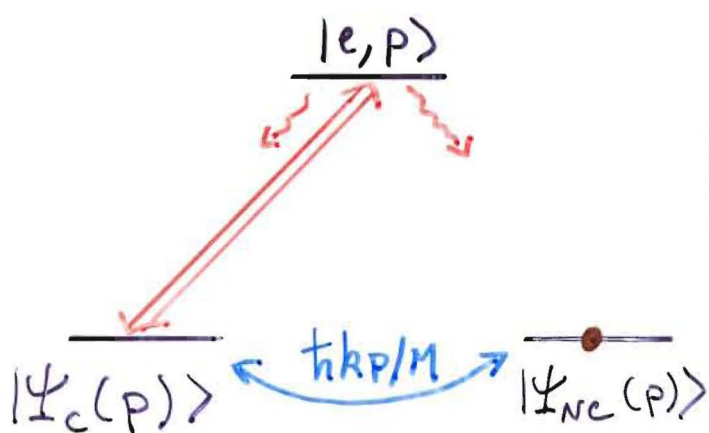

Because of coupling to $|\Psi_c(P)\rangle$ (fluorescence rate Γ') the atom leaves $|\Psi_{NC}(P)\rangle$

at a rate $\Gamma''(P) = \frac{1}{\Gamma'} \frac{k^2 P^2}{M^2}$

$|\Psi_{NC}(P=0)\rangle$ is a perfect trap.

→ In counterpropagating beams, C.P.T. is Velocity Selective

VSCPT Cooling

Atom characterized by the
 generalized momentum p : evolves
 inside the family $\mathcal{F}(p) = \{ |\Psi_{nc}(p)\rangle; |\Psi_c(p)\rangle; |e, p\rangle \}$ (laser interaction)

When a fluorescence photon is emitted
 from $|e, p\rangle$: random recoil $-\hbar k \leq \Delta p \leq \hbar k$

→ New family $\mathcal{F}(p')$

→ random walk of p

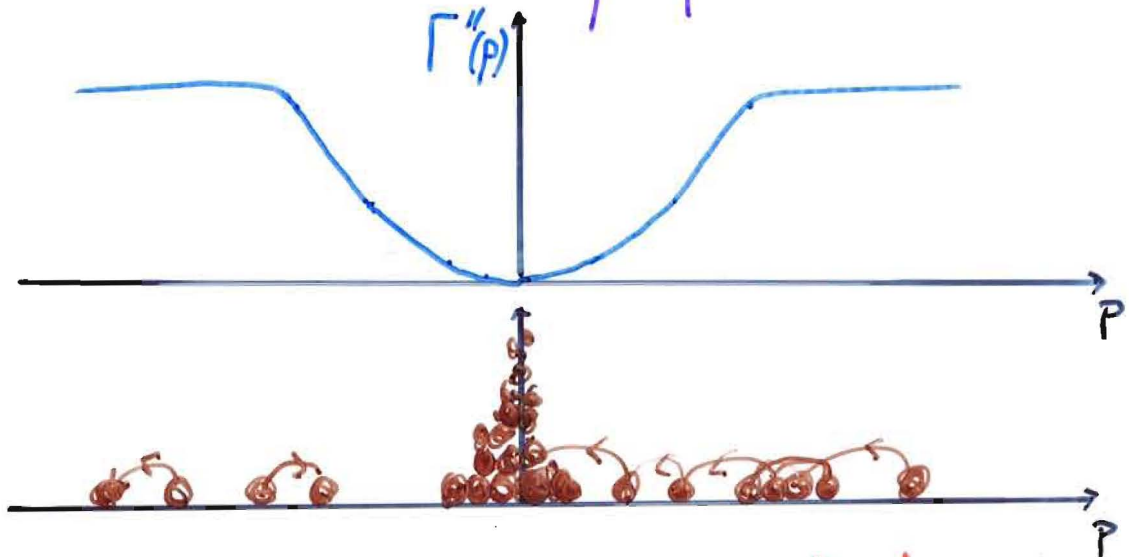

Atoms eventually accumulate in

$|\Psi_N(p)\rangle$ with $p \approx 0$

Cooling!

VSCPT \rightarrow atoms accumulated in.

$$|\Psi_{\text{NC}}(p=0)\rangle = \frac{1}{\sqrt{2}} (|g_-, -\hbar k\rangle - |g_+, +\hbar k\rangle)$$

Momentum measurement?

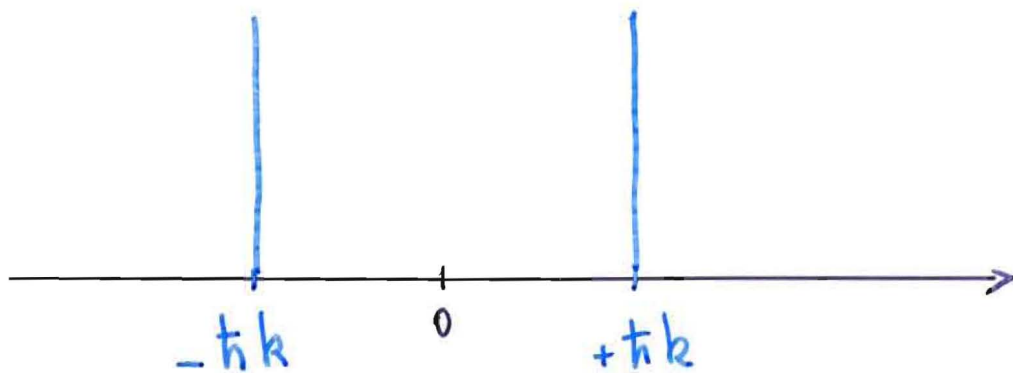



Sub. recoil cooling: $\delta p < \hbar k$
Separated double peak

Experiment with He^*

on the $2^3S_1 \leftrightarrow 2^3P_1$ transition

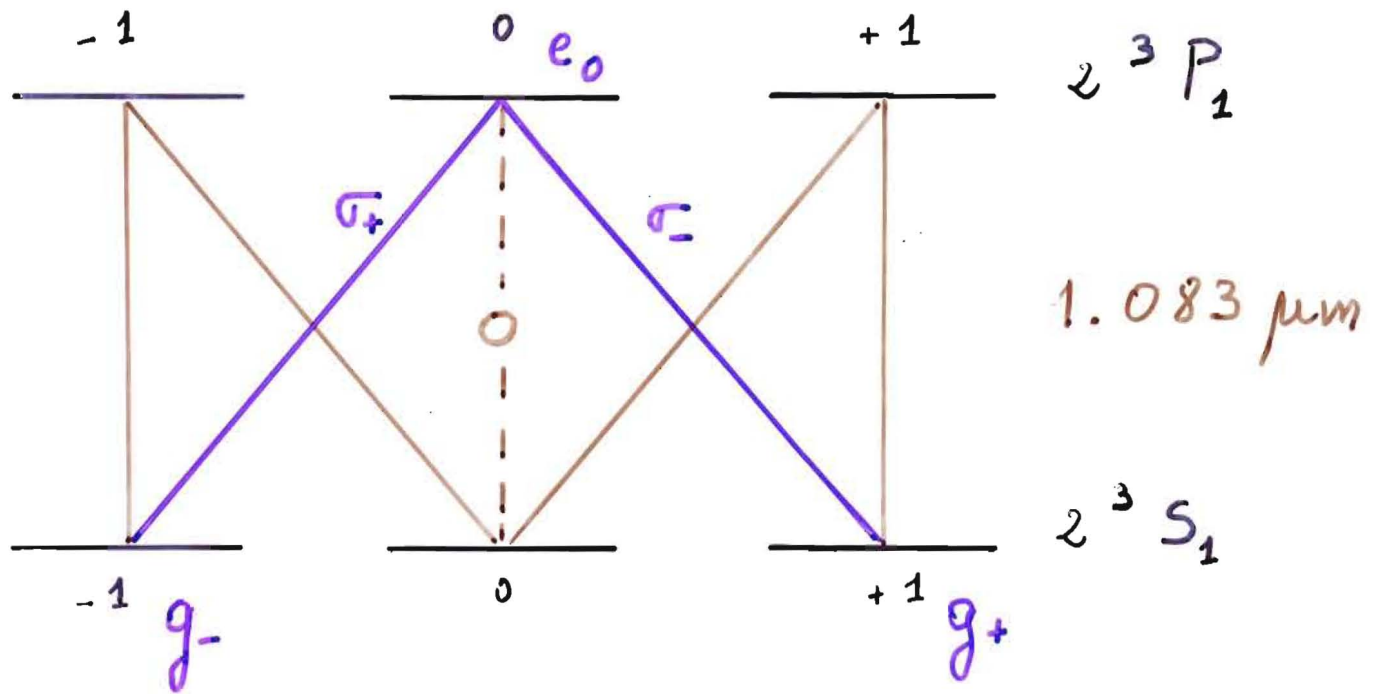

* $0 \leftrightarrow 0$ transition forbidden
→ after a few fluorescence cycles,
with σ_{\pm} polarized light,

Optical Pumping into the

Λ -3-level system

1 D subrecoil cooling (1988, ENS)

(A.A., E. Arimondo, R. Kaiser, N. Vansteenkiste, CCT)

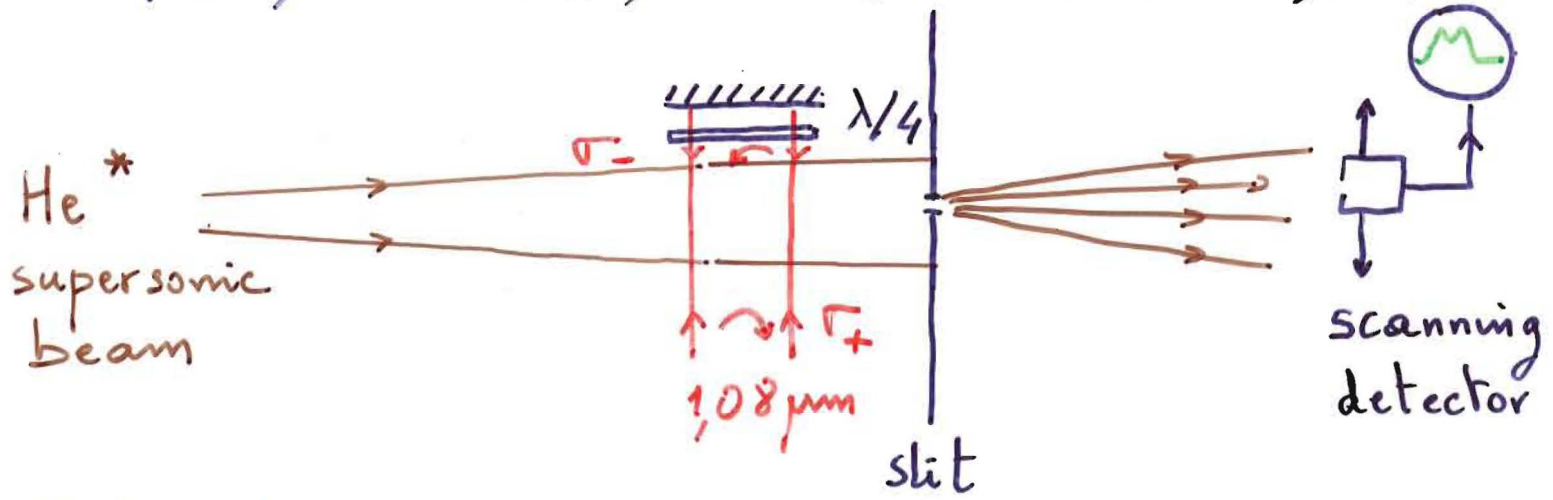

$$\text{Interaction time} = \frac{33 \text{ mm}}{1100 \text{ m/s}} = 30 \mu\text{s}$$

Important requirements

- preserve coherence σ_{g-g+}
 - magnetic field compensated better than 1 mG
- constant phase difference between σ_+ and σ_- counterpropagating beams
 - both beams derived from the same laser (jitter unimportant)
 - second Quarter Wave Plate ($\lambda/4$) and mirror: high optical grade

. Transverse velocity measurement

. Slits 0.1 mm wide separated by
1.4 m

. Average longitudinal velocity
1100 m/s

→ resolution in transverse velocity
 $\sim 4 \text{ cm/s}$ (H.W.H.M.)

(one photon recoil $\frac{\hbar k}{M} = 9 \text{ cm/s}$)

. Interaction time

$$T \lesssim 350 \Gamma^{-1}$$

Experimental Result

Transverse Velocity Distribution

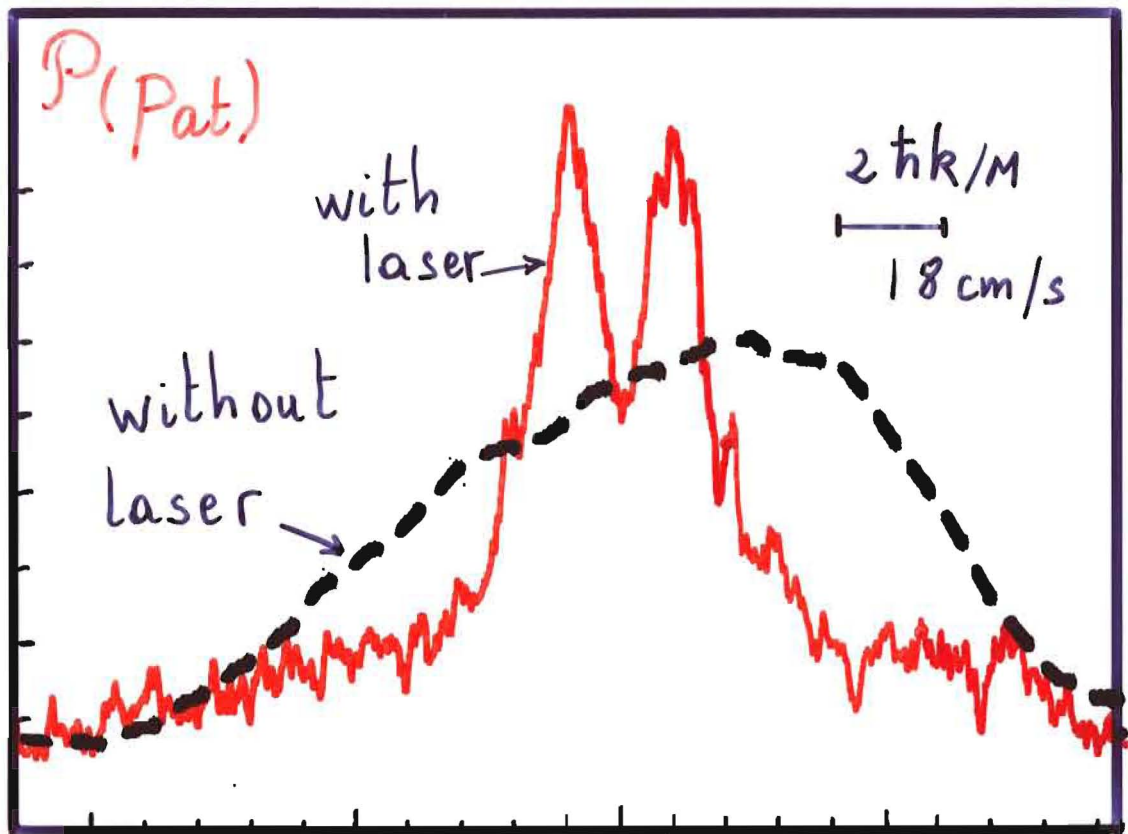

• zero detuning

• $\omega_1 = 0.6 \Gamma$ per wave

* Peak width, without deconvolution

H. W. at $e^{-\frac{1}{2}}$: 6 cm/s $\sim \frac{\hbar k}{M}$

* Corresponding Transverse "Temperature"

$2 \mu\text{K}$

* Real cooling: density (velocity) increases!

What are the limits/potentialities of sub-recoil cooling?

- Limit temperature?
- Proportion of cooled atoms?
- Shape of the momentum distribution?
- Dependence on interaction time?
 - Steady state?

Results of the Optical Bloch Equations Numerical Integration

$$\omega_L = \omega_{At}$$

$$\omega_1 = 0.6 \Gamma$$

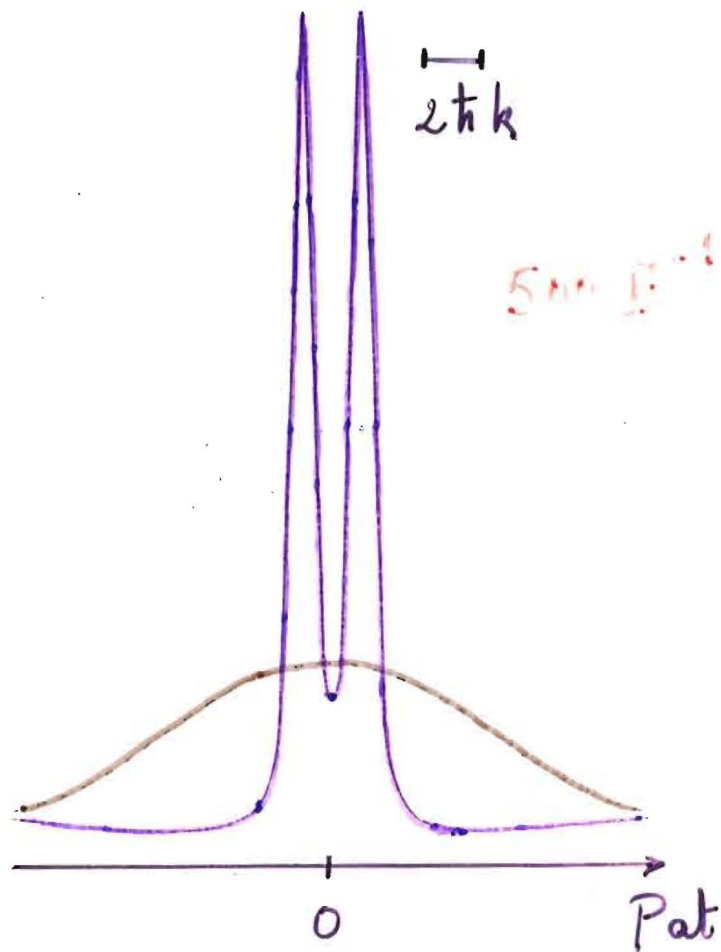
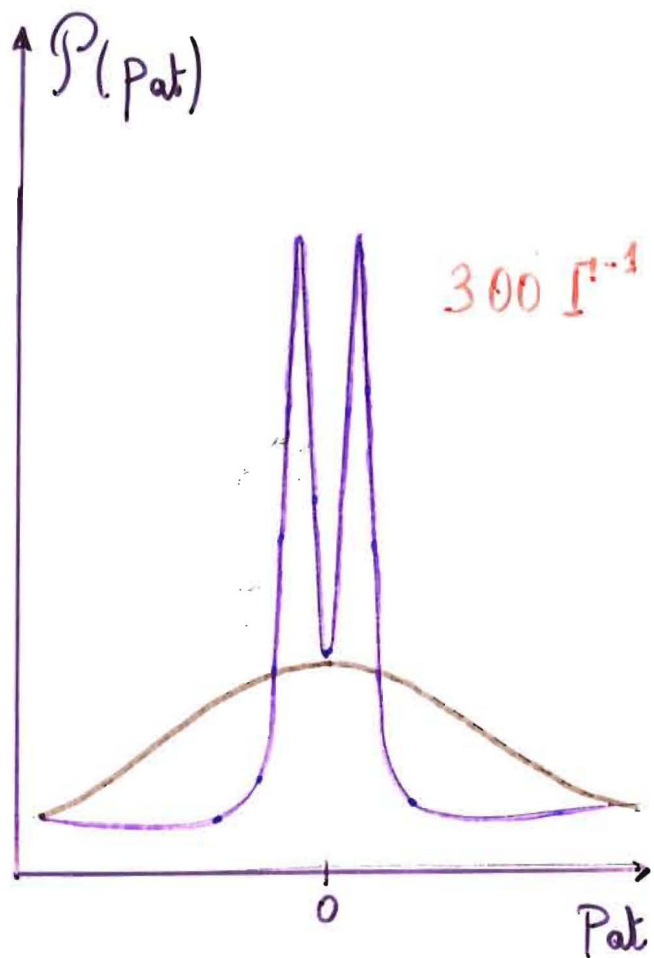
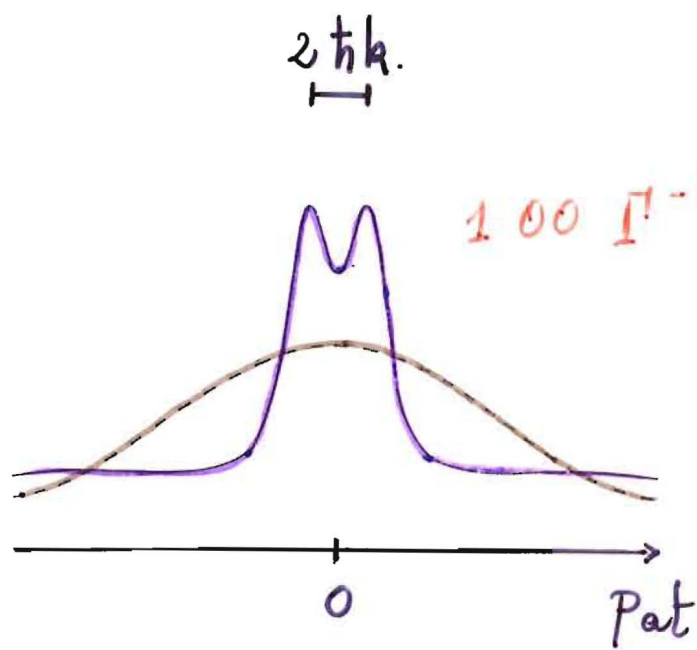
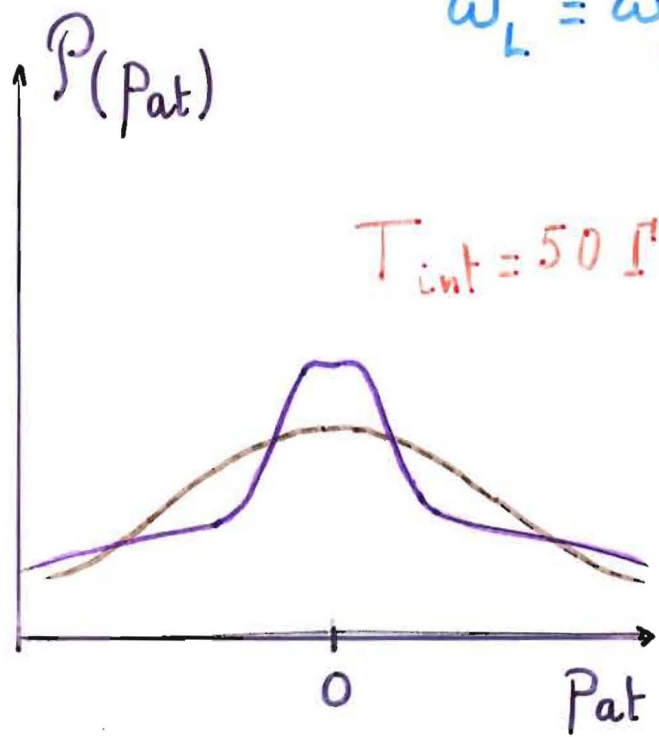

Peak width

(Numerical solutions of the O.B.E.)

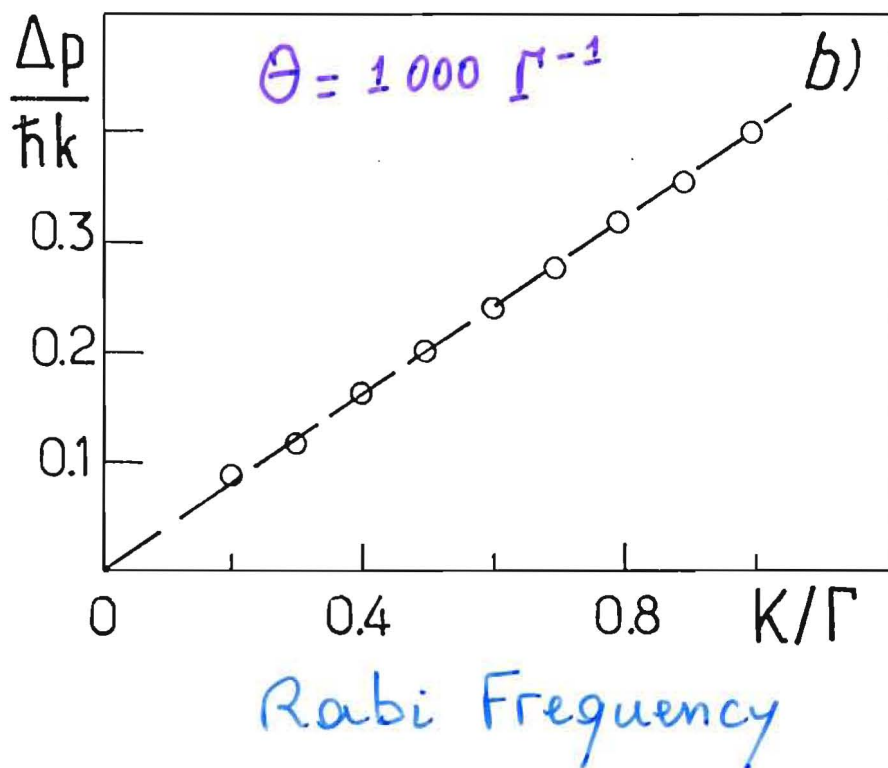
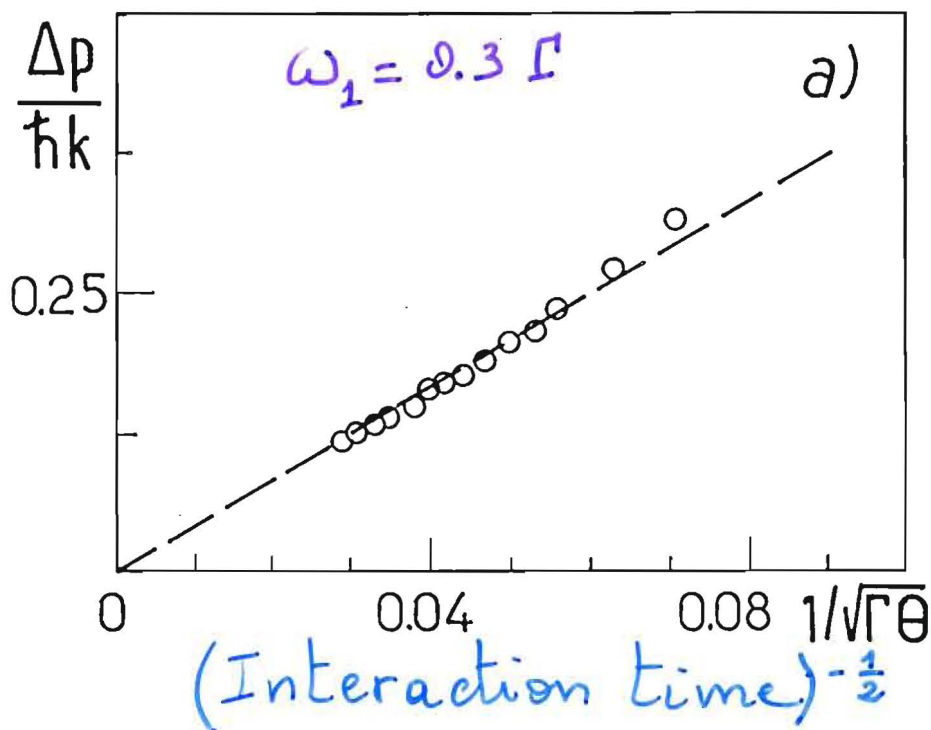

The peak width can be arbitrarily small, at arbitrarily long times ???

Numerical Integration of Generalized Optical Bloch Equations

Interesting results for 1D VSCPT, at short interaction times ($\theta < 10^4 \Gamma^{-1}$)

$$\bullet \delta p \propto \frac{1}{\sqrt{\theta}} \iff T \propto \frac{1}{\theta}$$

• peak height \nearrow : cooling

• peak area \nearrow

But too demanding in computing power to extend at

• long interaction times; asymptotic behaviour?

• 2D, 3D

A more efficient Quantum Optics
numerical calculation: Quantum Jump
description based on the delay function
(F. Bardou, A.A., C.C.-T).

Two types of evolution:

- coherent evolution in a family $\mathbb{F}(p)$
(p stays constant)
- fluorescence emission: quantum jump.
 p changes randomly $\rightarrow p'$
 \rightarrow new coherent evolution in $\mathbb{F}(p')$

Quantum Optics \rightarrow delay function $w_p(\tau)$
= probability distribution of the
waiting times τ in the family p .

Exact Quantum Optics calculation
 \rightarrow very efficient Monte-Carlo simulation
of the evolution of p .

Efficient implementation of M.C.W.F.

Monte-Carlo Simulation (F. Bardou)

Spontaneous emission at random times:
when p closer to 0, longer "dark" periods

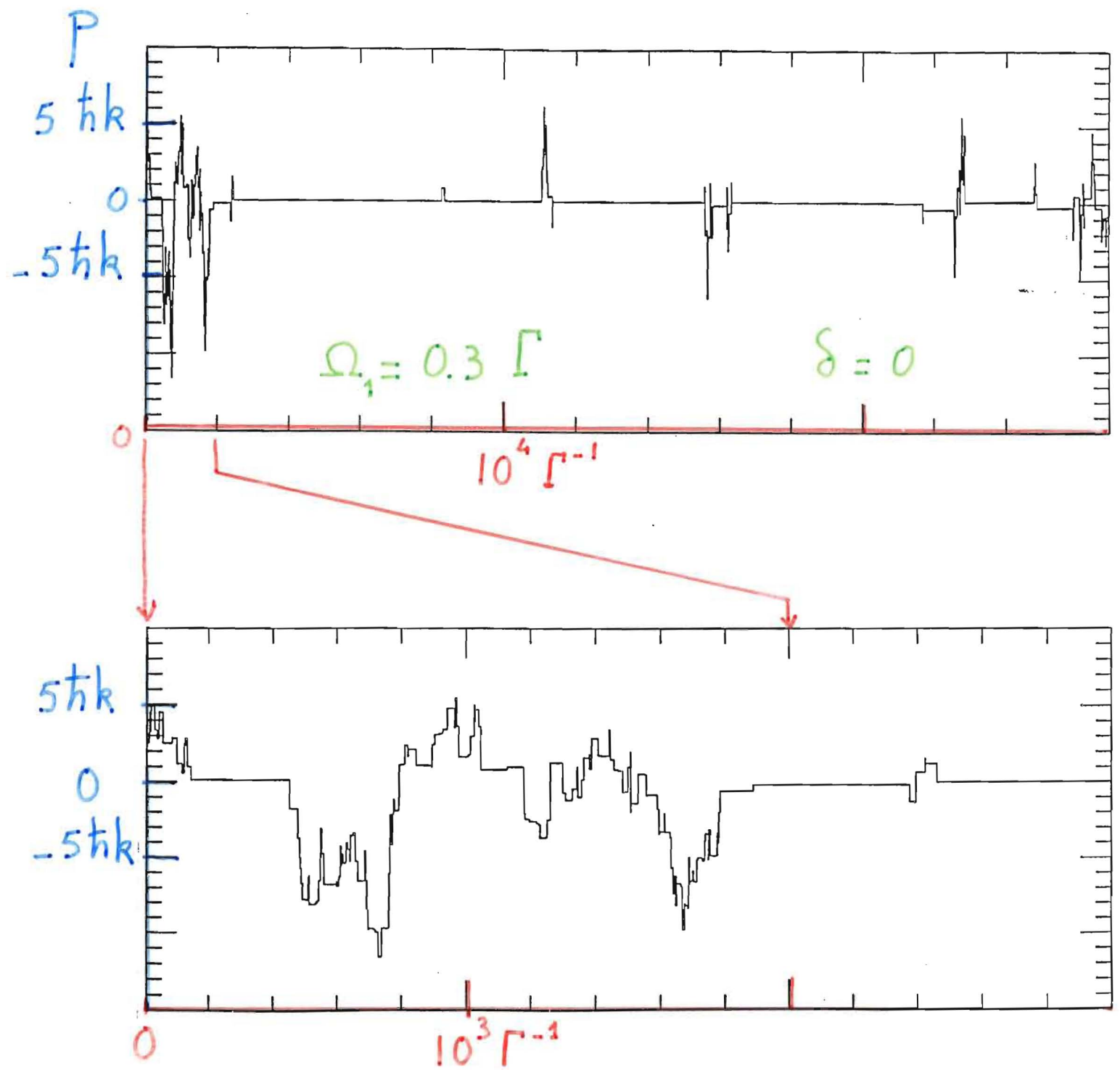

Monte Carlo simulation

(F. BARDOU)

Momentum distribution

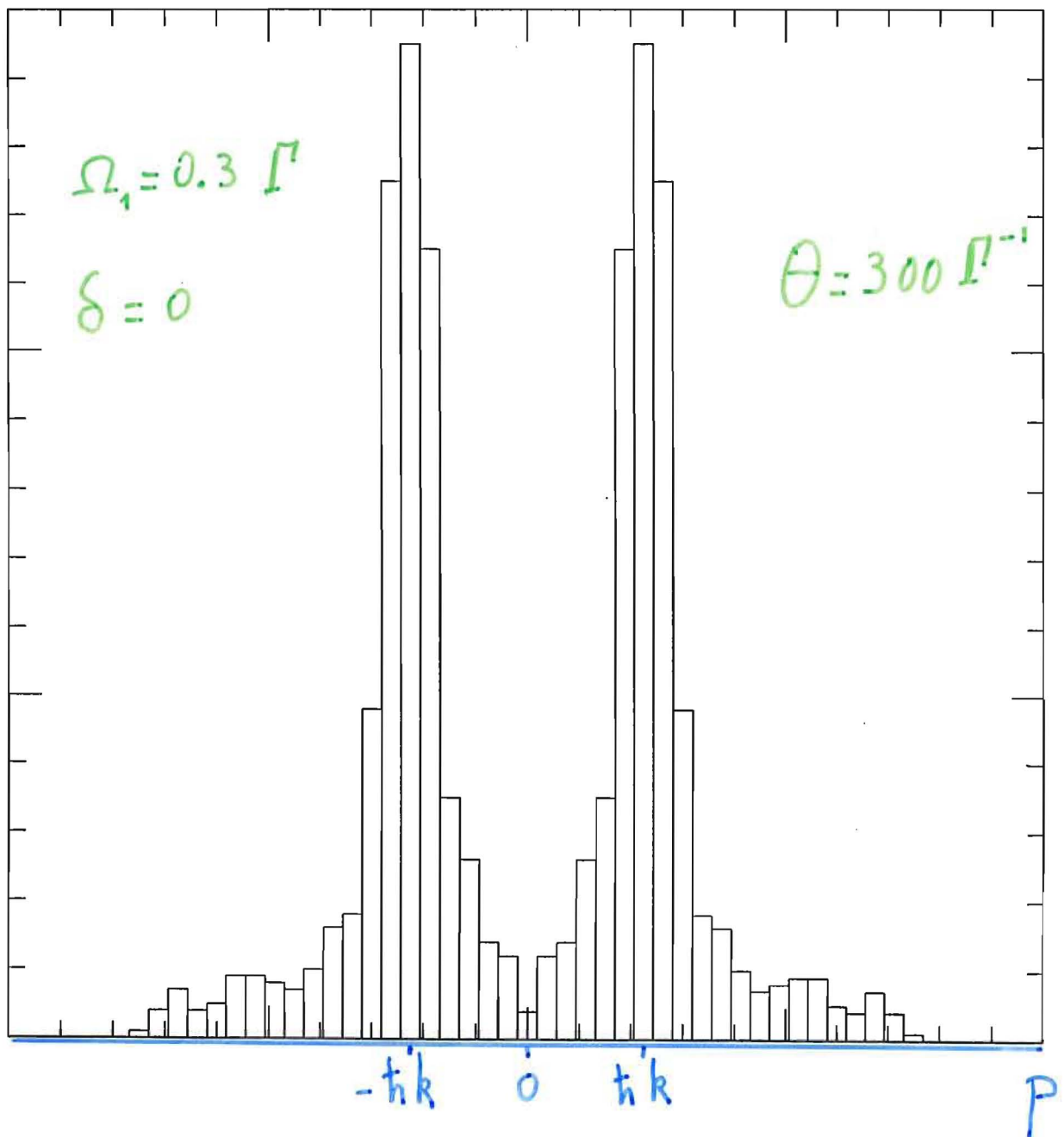

The Monte Carlo calculation confirms the $\frac{1}{\sqrt{\theta}}$ law for the width of the peak of trapped atoms, at interaction times as long as $10^6 \tau^{-1}$.

It yields the fraction of atoms cooled (trapped): efficiency of the method.

It suggests an unusual statistical behaviour for which theoretical methods exist: Lévy flights (coll. with J. P. Bouchaud)

⇒ asymptotic behaviour of the atomic momentum distribution

Quantum Jump Simulation (delay function)

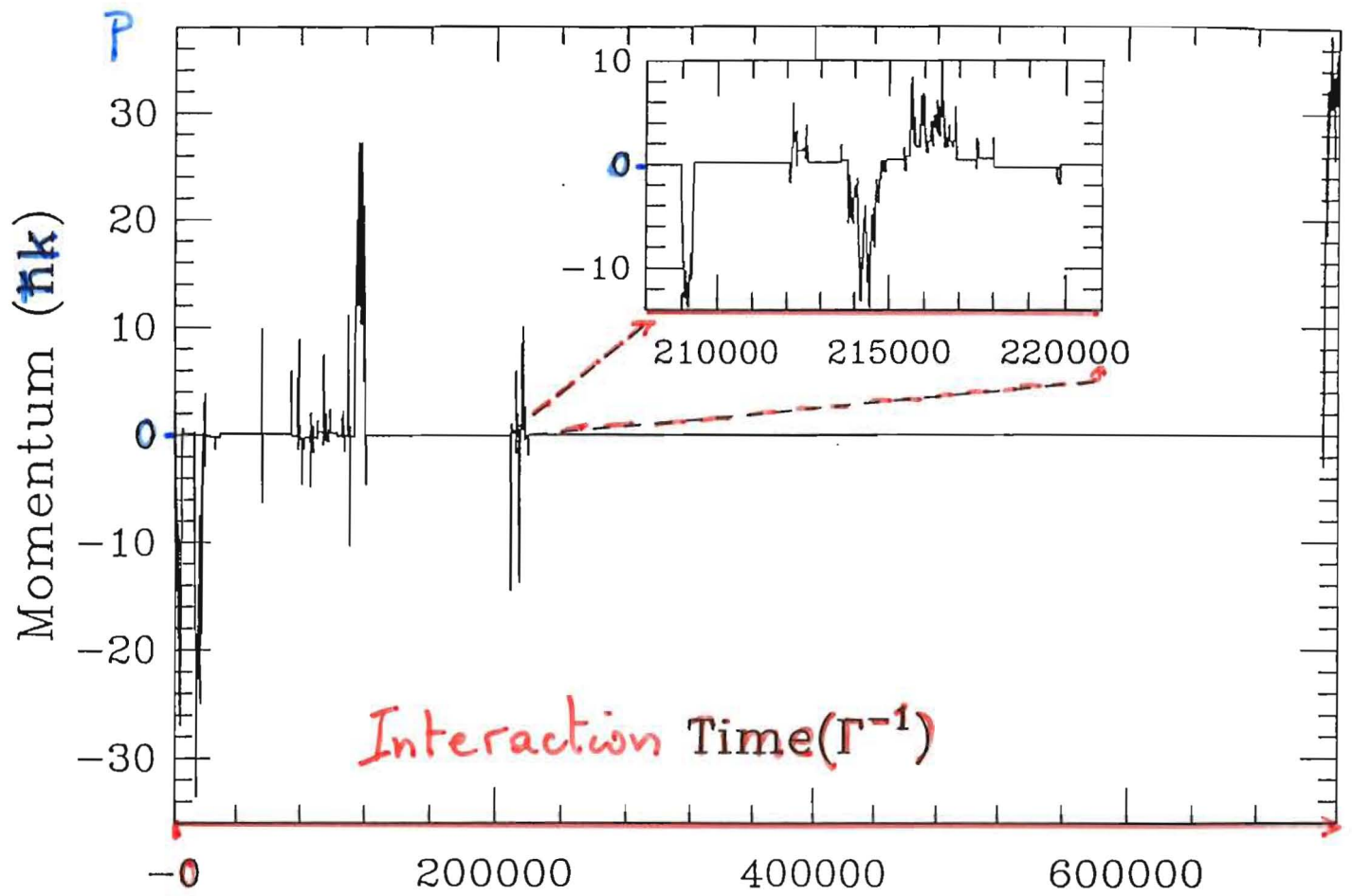

A very small number of events (trapping dark states) dominate the whole interaction time.

The trapping times probability distribution is a broad law: unusually large trapping times have a non-negligible probability

⇒ Unusual statistical behaviour

Statistics of the trapping times

in 1D VSCPT

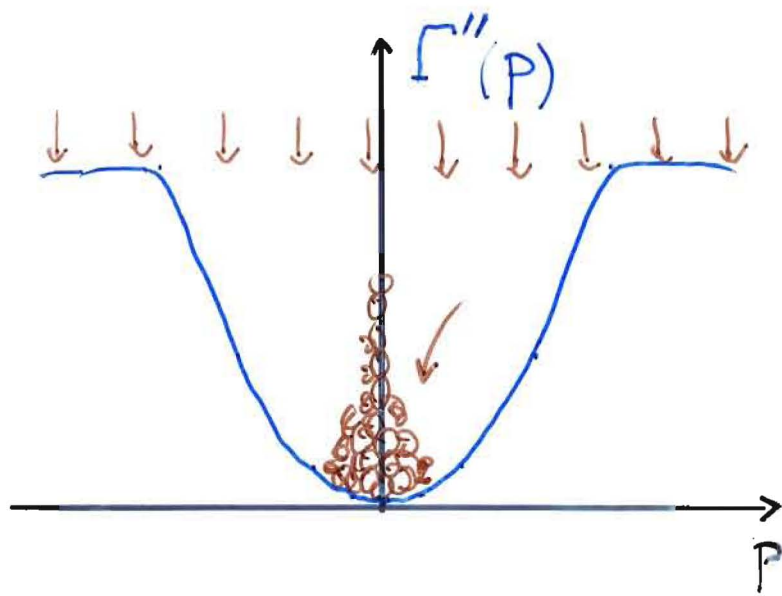

An atom falling in $\Psi_{nc}(P)$ is trapped for a time

$$\tau \propto \frac{1}{P^2}$$

$\tau \rightarrow \infty$ when $P \rightarrow 0$

Probability distribution of the trapping times

$$P(\tau) = 2 \rho(P) \frac{dP}{d\tau} \stackrel{\text{uniform}}{\propto} \frac{1}{\tau^{\frac{3}{2}}} = \frac{1}{\tau^{1+\mu}}$$

Broad law (long tail for $\tau \rightarrow \infty$)

$$\langle \tau \rangle = \int \tau P(\tau) d\tau \rightarrow \infty !$$

Diverges for $\mu < 1$ (Here $\mu = \frac{1}{2}$)

Sum of the trapping periods
(1D VSCPT)

$$T_N = \sum_{i=1}^N T_i \quad (\text{with } P(T_i) \propto \frac{1}{2 T^{3/2}})$$

↓
is not equal to $N \langle T_i \rangle$!

(Central Limit Theorem does not apply)

T_N is a Lévy sum

$$T_N = T_{\text{trap}} N^2 \xi \quad \begin{array}{l} \rightarrow \text{random variable} \\ \text{of order } 1 \text{ (Lévy law)} \\ \text{large fluctuations} \end{array}$$

Scales as N^2 for $N \rightarrow \infty$

The largest term of the sum $T^{(1)}$
is of the order of T_N (see simulation)

Lévy statistics analysis of subresonant cooling (VSCPT, Raman, 1D, 2D, 3D...)

Precise predictions of asymptotic behaviour (large interaction time θ)

- width Δp_θ and shape of momentum distribution
- fraction of cooled atoms
- density in p space (peak height)

Depend only on the behaviour of $P(\tau)$ at large τ (exponent of power law) not on the details of the waiting time distribution

Sophisticated quantum optics calculations can be replaced by simplest models

Statistical Physics type of approach

Efficiency of VSCPT cooling

Monte-Carlo simulations (\square)

Lévy flight analysis

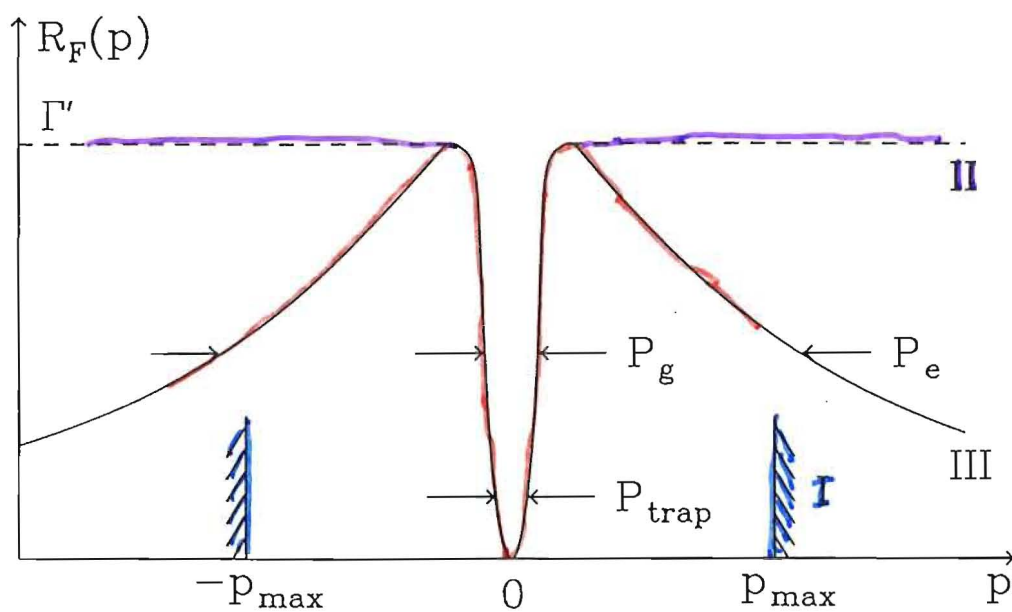
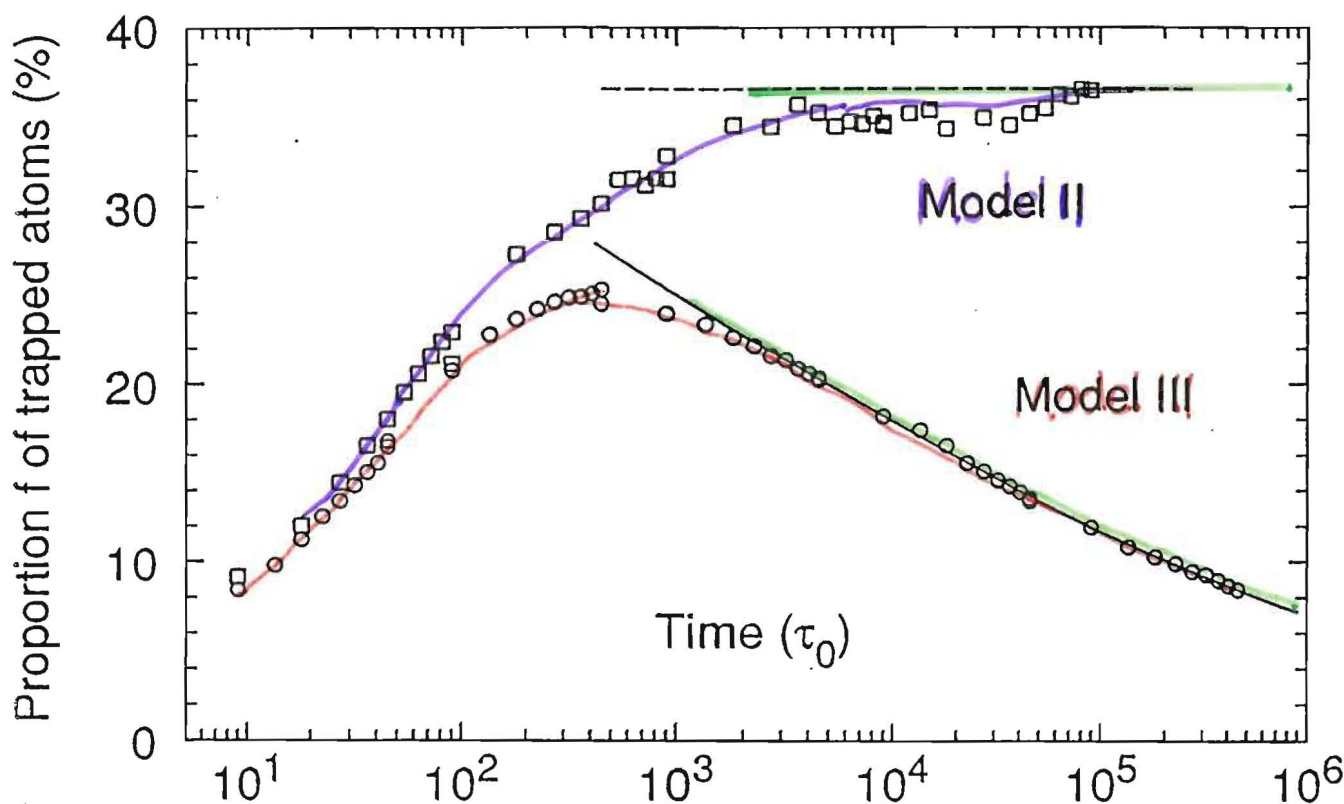

For model I ("walks" in the p space)

\rightarrow 100% efficiency

Some important results of the statistical analysis

- Role of dimensionality: $P(\tau) \propto \frac{1}{\tau^{5/2}}$: 3D

Not a broad law: a priori not efficient
→ strong recycling necessary: exp. observed

- Role of the recycling: recycling times may also obey Lévy statistics (first return time of Brownian motion) → precise predictions: tested with Quantum Jump Monte Carlo simulation (delay function)

- Role of the shape of jump rate

$$\Gamma''(p) \propto \frac{1}{p^\alpha} \rightarrow P(\tau) \propto \frac{1}{\tau^{1+\frac{D}{\alpha}}}$$

→ cooling depends on D/α

Experimentally checked in Raman subrecoil cooling (J. Reichel, F. Bardou, ... C. Salomon, C.C.-T.)

Momentum distribution and temperature: Asymptotic behaviour

At the end of the interaction time θ the atom is most probably in a state with a trapping time of the order of θ , or larger

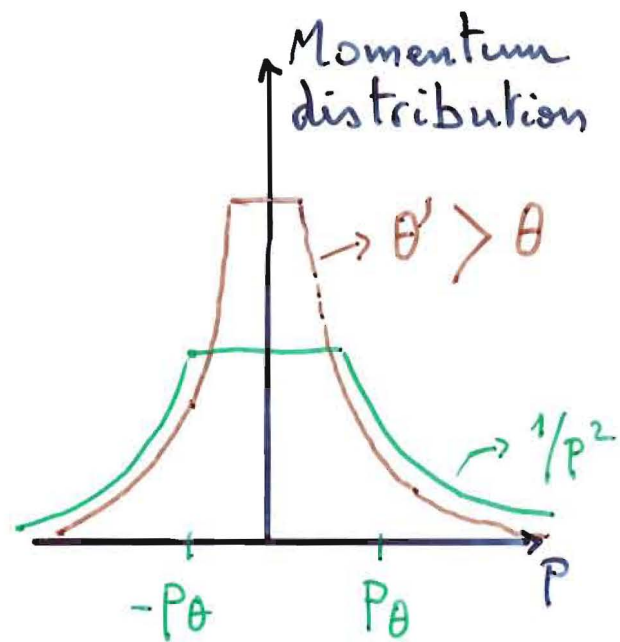
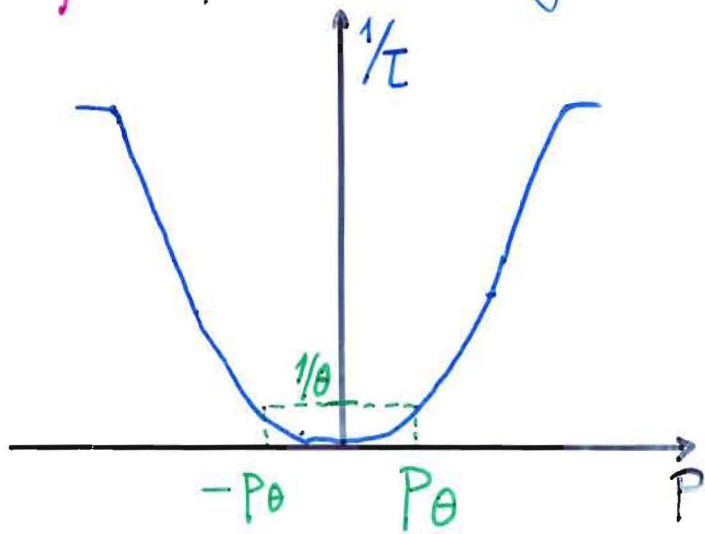

Width of the momentum distribution
 $\sim p\theta \propto \frac{1}{\sqrt{\theta}}$

"Temperature" $\propto \frac{1}{\theta} \rightarrow 0$ for $\theta \rightarrow \infty$

The prefactor only depends on the tail of $P(\tau)$ for large τ : (i.e. of curvature)

Asymptotic decrease of temperature

$T \rightarrow 0$ when interaction time $\theta \rightarrow \infty$

But ∞ is not very much

$$\theta = 30 \mu\text{s} \rightarrow T = \frac{T_R}{2} \quad (1988)$$

$$\theta = 300 \mu\text{s} \rightarrow T = \frac{T_R}{20} \quad (1994) \quad \text{but}$$

with insufficient resolution (deconvolution rather suggested $\frac{T_R}{60}$)

Recent measurements of Δp by measurement of spatial coherence (B. Saubaméa ...)

$$\theta = 2000 \mu\text{s} \rightarrow T = \frac{T_R}{800} = 5 \text{ mK} \quad (\text{He}^*)$$

Wave packet width $\sim 20 \mu\text{m}$!

In order to test

- longer interaction times
- 2D and 3D cooling

New generation of experiment

Longer interaction times in smaller interaction regions (B must be cancelled below the mG)

Use cold atoms...

(F. Bardou, B. Saubaméa, J. Lawall, K. Shimizu, D. Emile, C. Westbrook, A. A., C. C.-T. : C. R. Acad. Sci. Paris, 318, p 877-885, 1994).

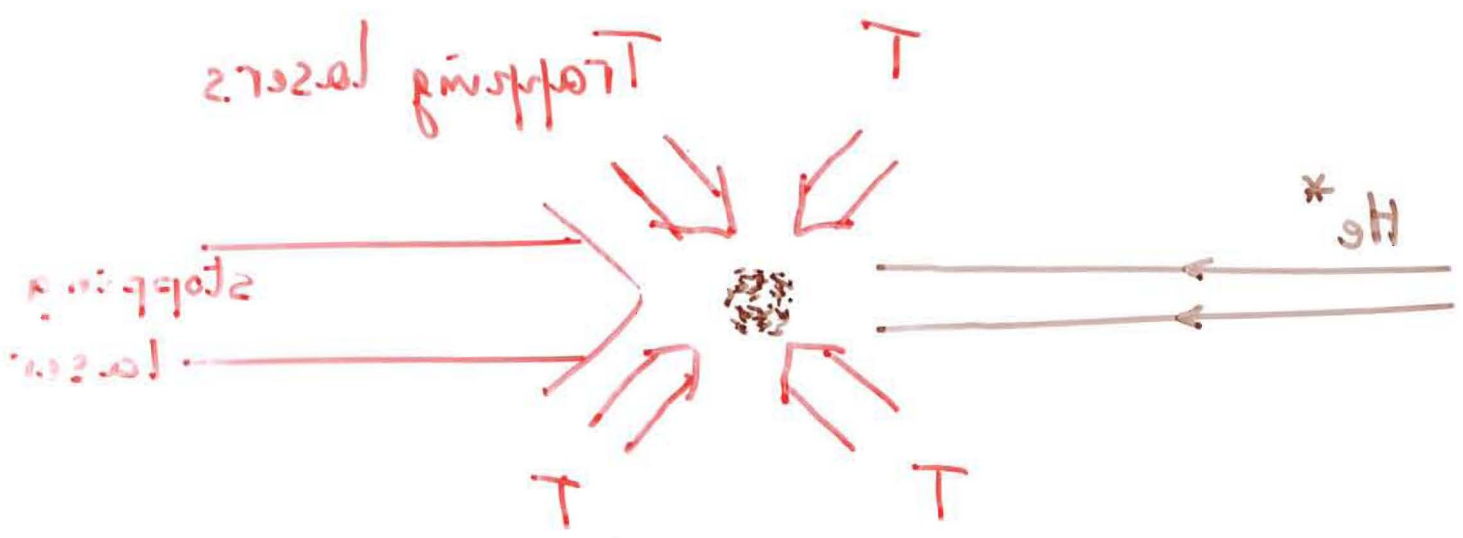

Trapped cold (2^3S_1) He^* constitute
a very interesting source of slow
(2^3S_1) He^* atoms

- * Release the trapped atoms at $t=0$
- * For 100 ms, one has falling atoms, with $v \lesssim 1 \text{ m/s}$, in a volume of a few cm



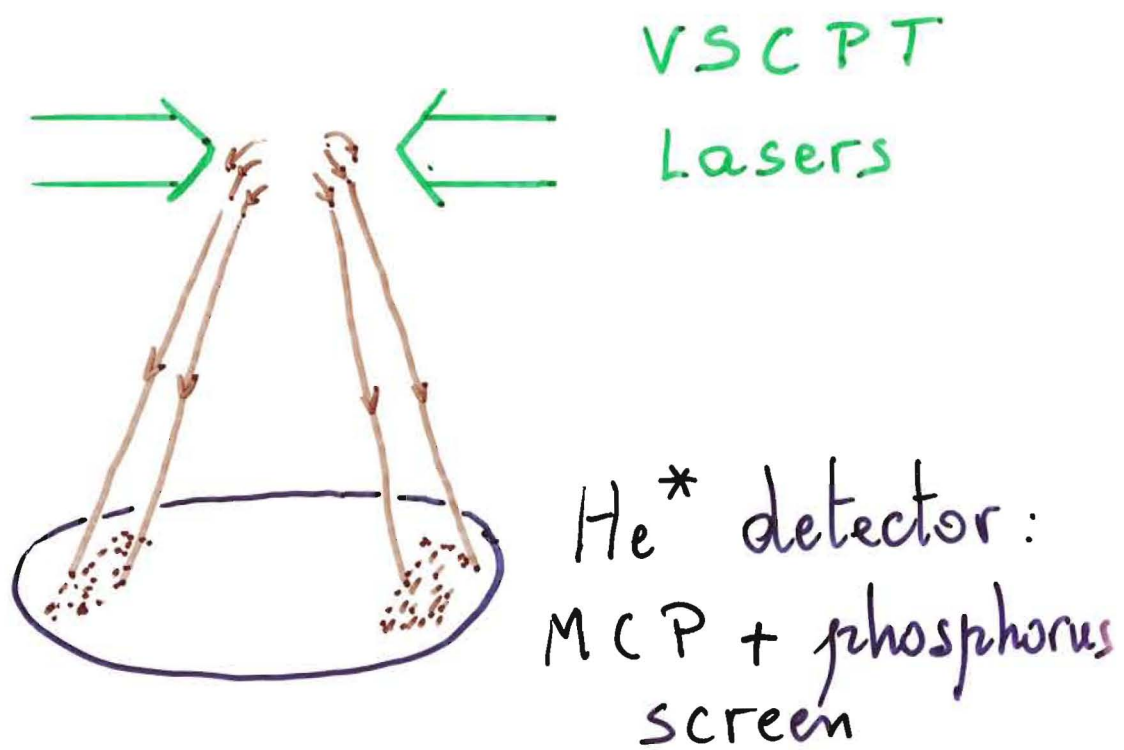

"Single Shot" - 1 release
of trap

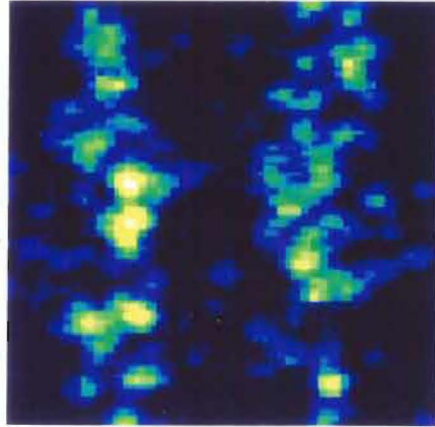

Integration of 80 shots

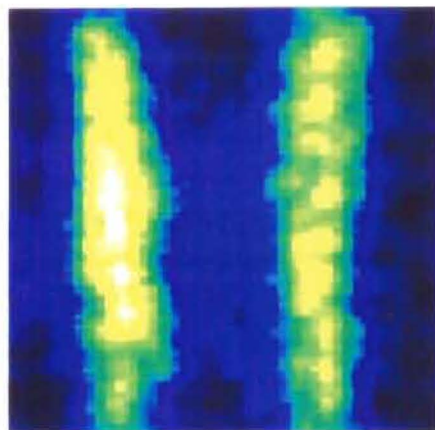

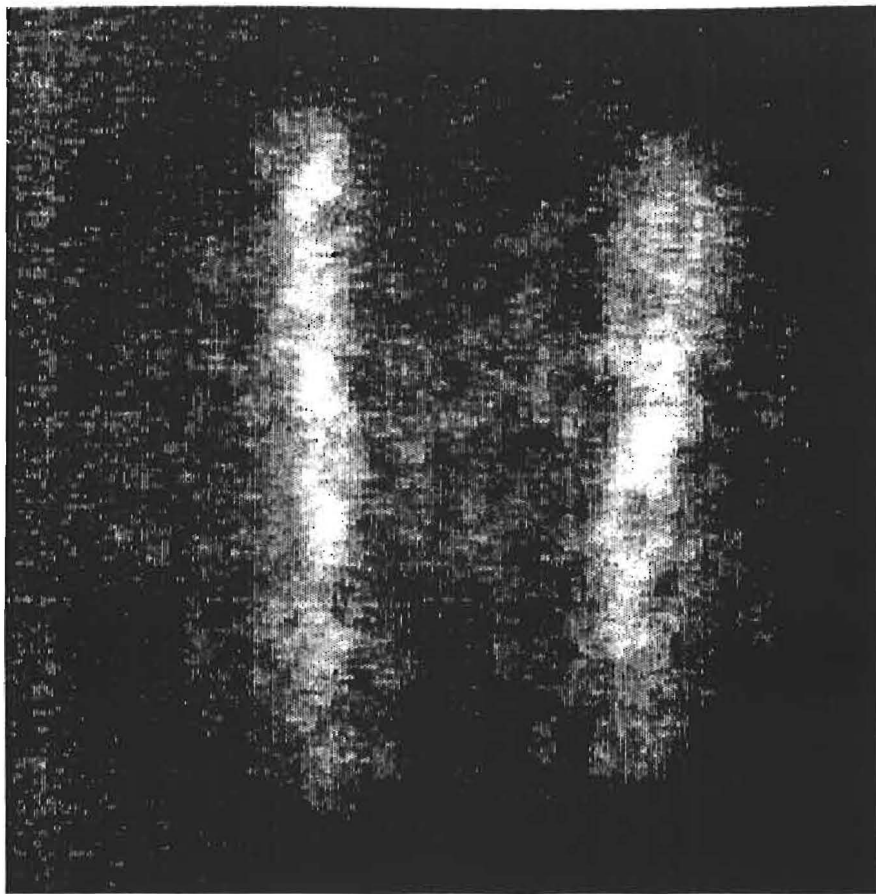

Exemple de
résultat

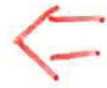

moyenne de
80 images

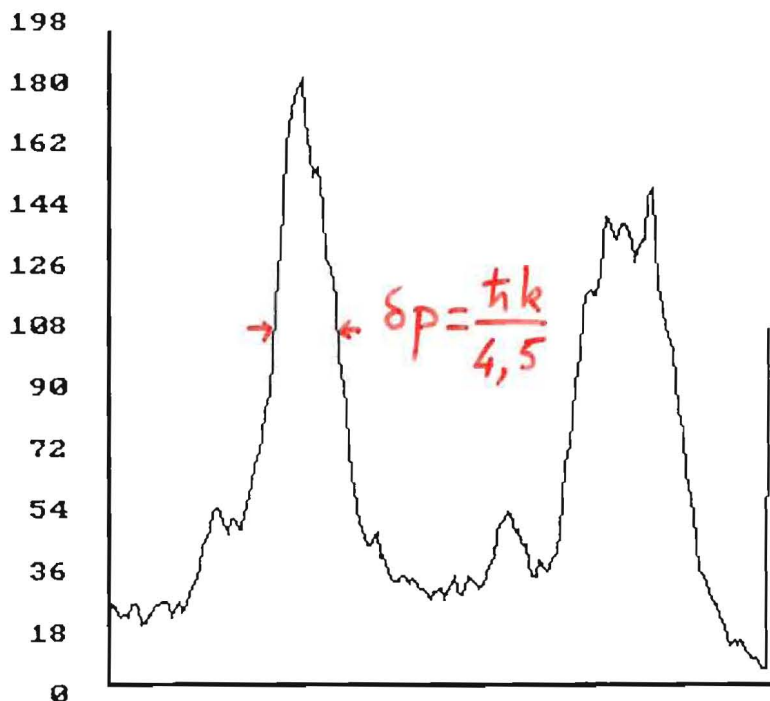

$$T = \frac{T_R}{20}$$

$$\approx 200 \text{ nK}$$

COL : 151 198 245 292 339
LIG : 177 177
MAX : 182
MIN : 3

Temps d'interaction: $\theta = 300 \mu s$

VSCPT can be generalized
in 2D and 3D

- ENS, Arimondo & Mauri
- J'l Shani & Mingin

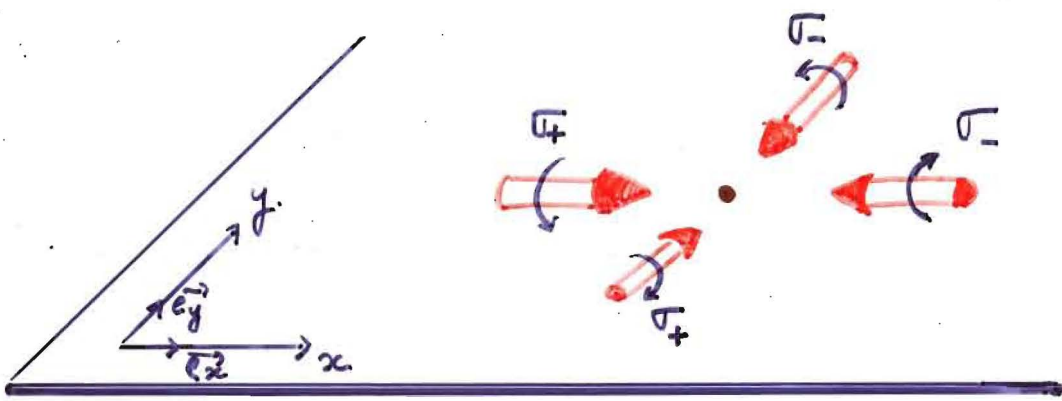

For a $J_g = 1 \leftrightarrow J_e = 1$ transition, perfect trapping state $|\Psi_{nc}(\vec{P}=0)\rangle$ "isomorphic" to the light field

Example: 2D situation with 4 σ_+/σ_- waves:

$$|\Psi_{nc}(0)\rangle = \frac{1}{2} |m_x = 1, \hbar k \vec{e}_x\rangle + \frac{1}{2} |m_x = -1, -\hbar k \vec{e}_x\rangle \\ + \frac{1}{2} |m_y = 1, \hbar k \vec{e}_y\rangle + \frac{1}{2} |m_y = -1, -\hbar k \vec{e}_y\rangle$$

Each atom has 4 momentum components

Observation of 2-D VSCPT

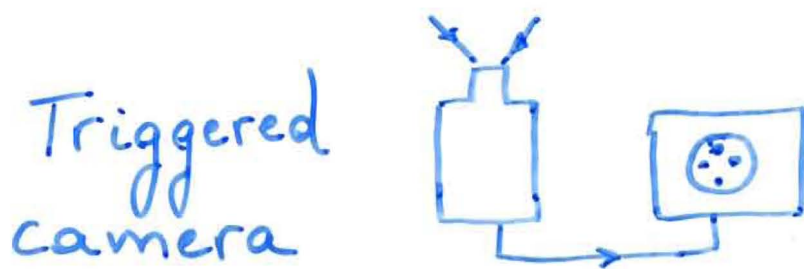
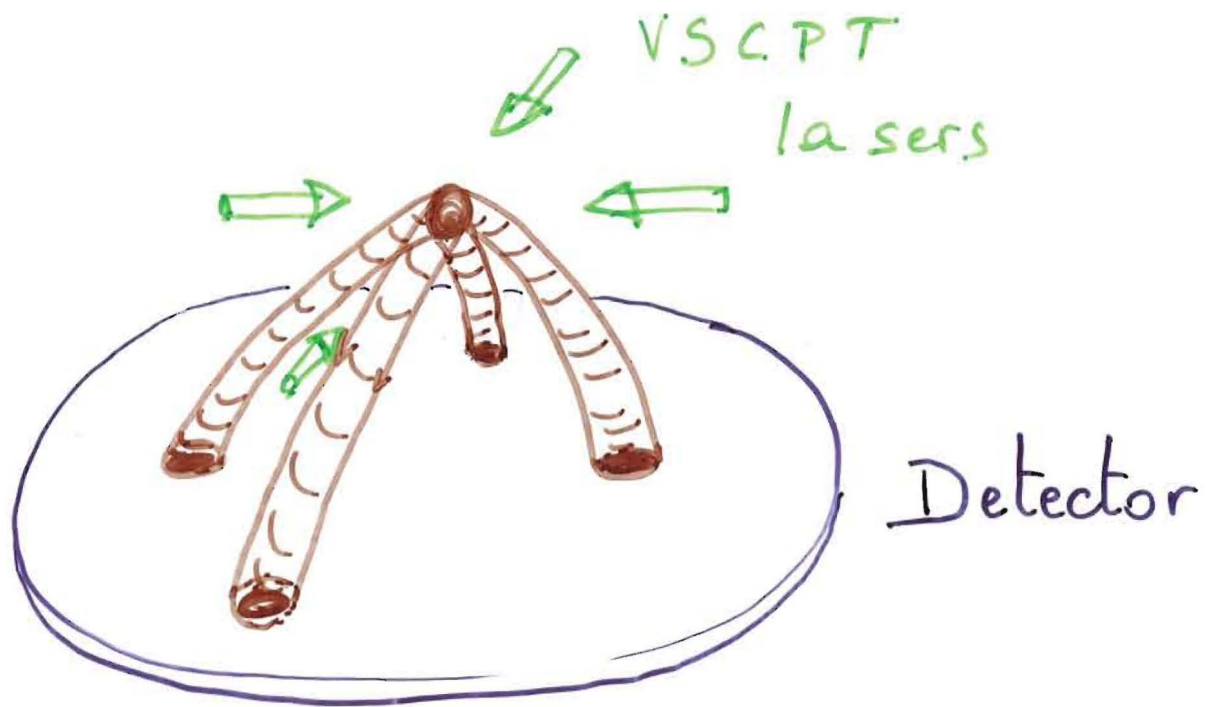

4 spots expected at a distance from center

$$d = \frac{\hbar k}{M} t_{\text{fall}}$$

t_{fall} can be adjusted.

2D, VSCPT cooling

(J. Lawall, F. Bardou, B. Saubaméa, K. Shimizu, M. Leduc, A.A., C.C.-T.) (1994)

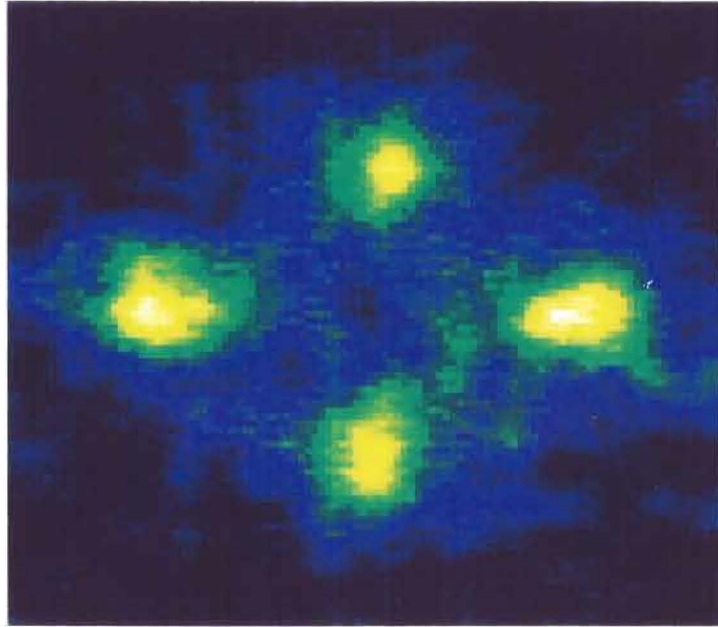

$$\theta = 500 \mu\text{s}, \quad \Omega_1 = 0,8 \Gamma, \quad \delta = +0.5 \Gamma$$

$$T \sim \frac{T_R}{20} \sim 200 \text{ nK}$$

No effect observed for $\delta < 0$:
role of Sisyphus to "attract" atoms
towards $p = 0$

VSCPT 3D cooling

3 components of velocity measured by monitoring position and detection time on a position detector

Dark resonance cooling with 6 beams σ_+ / σ_- polarized:

Result: * 6 peaks in velocity space with subrecoil width

$$T \sim \frac{T_R}{40} = 100 \text{ nK} \quad \left(\theta = 2 \text{ m s} \right) \\ \left(\delta = +\Gamma \right)$$

Adiabatic transfer in 1 peak

Atom transfer (2D) using μ adiabatic transfer in 1 peak

(S. Kulin, B. Soubamía, E. Peik, J. Lawall, T. Hijmans, M. Leduc, C.C.T.: 1997).
(see also Esslinger & co., Rubidium, 1D)

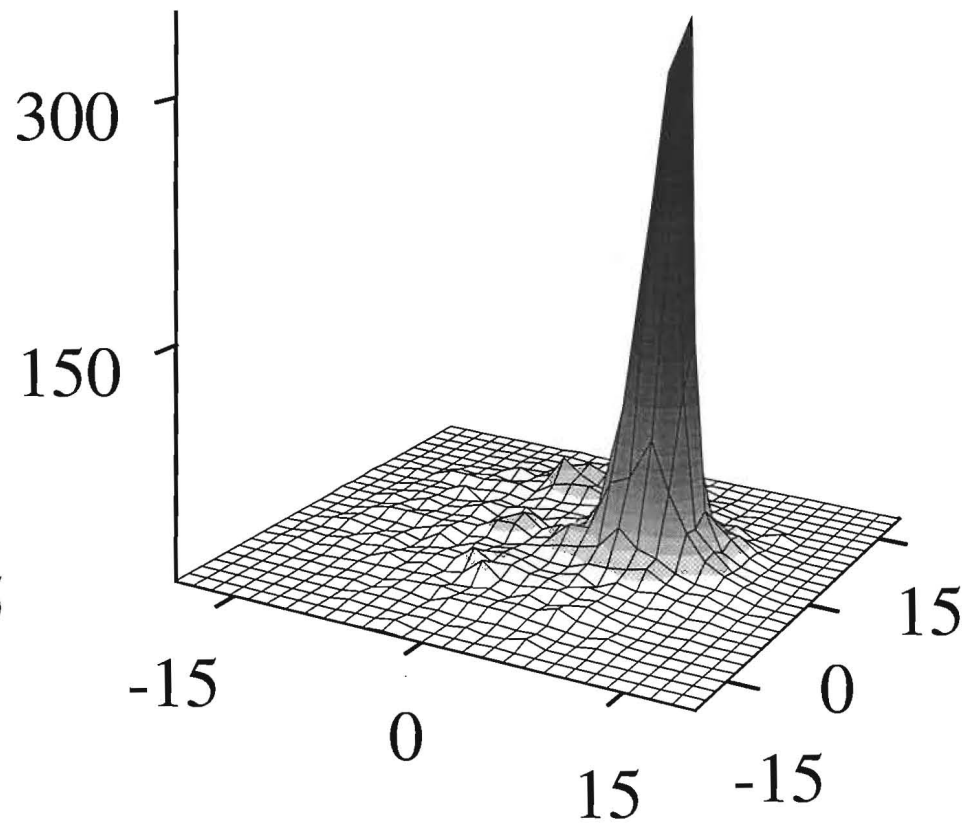
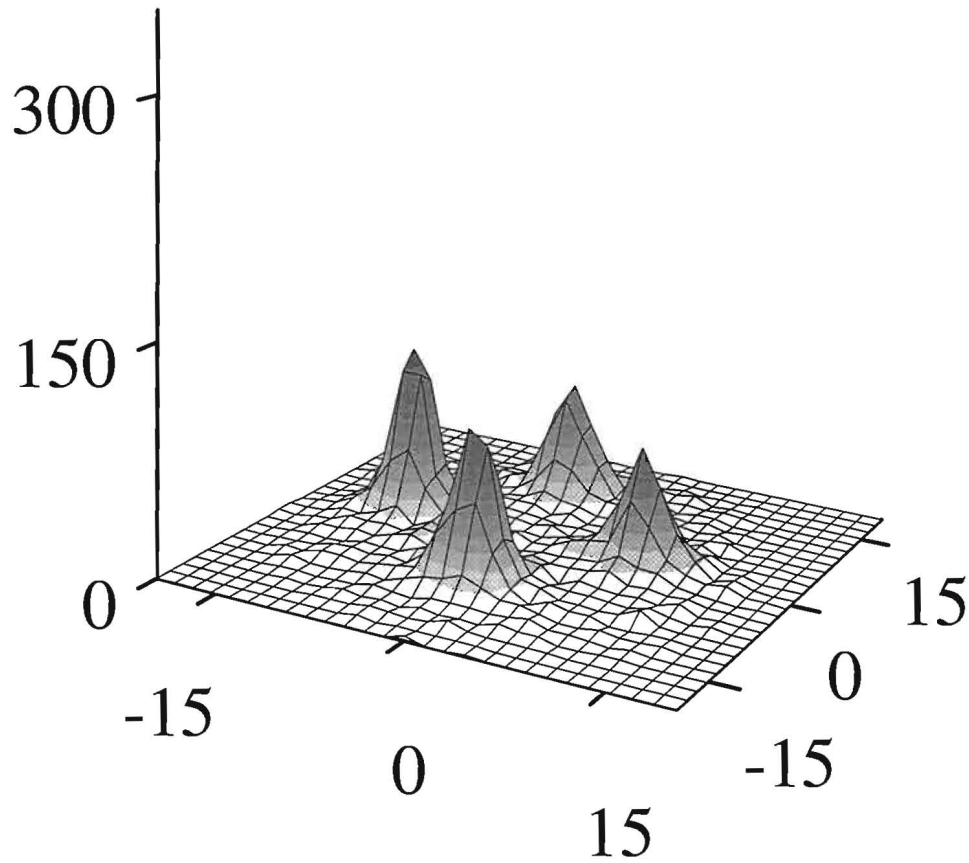

Transfer efficiency: 30%

No heating during transfer: $T \sim \frac{T_R}{40} \sim 100 \text{ nK}$

Raman sub-recoil cooling

(M. Kasevich & S. Chu, 1992)

Experiments in Stanford, and
ENS

Subrecoil cooling in 1D, and in
a trap

Efficient cooling in 2D and 3D
($T \sim T_R$)

Like VSCPT, Raman cooling
involves

- trapping around $p=0$: no more interaction with light.
- recycling atoms with $p \neq 0$ until they are trapped at $p=0$.

Conclusion

It seems a priori possible to cool without limits with VSCPT or Raman cooling.

It is the duration θ of the experiment that determines the final temperature

→ there is always a physical process with a characteristic time as long as θ .

→ NON-ERGODIC process

→ Deeply linked to Lévy statistics (failure of central limit theorem)

Asymptotic decrease of temperature

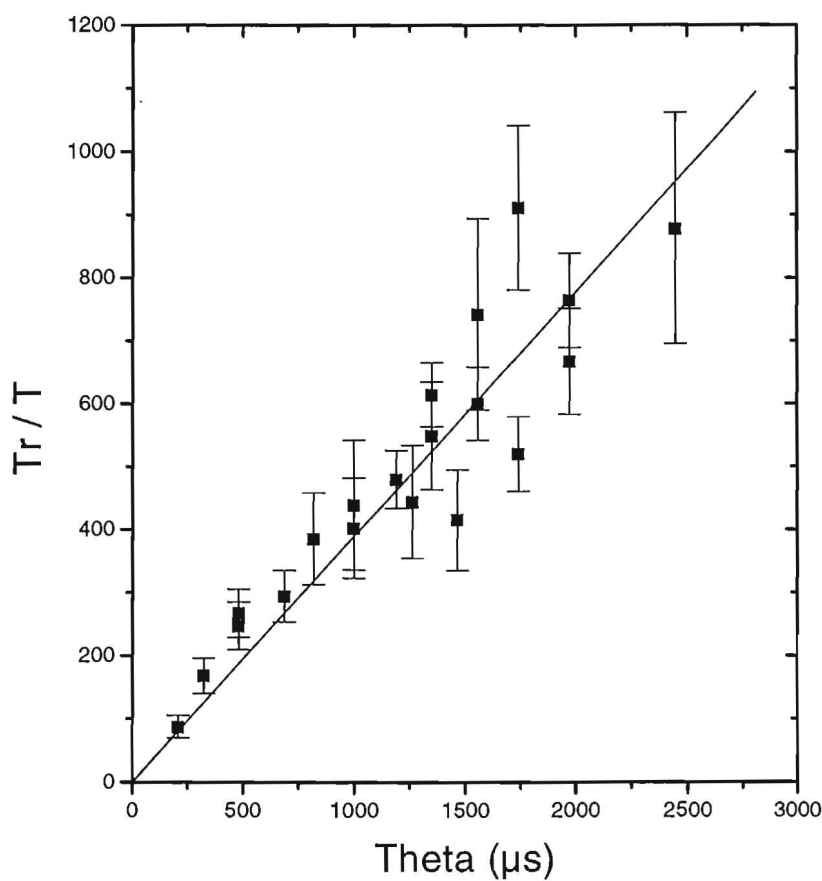

B. Saubamie, T. Hijmans, S. Kulin, E. Rasel,
E. Peik, M. Leduc, C.C.-T, PRL 79, 3146

Momentum distribution: wings in $\frac{1}{p^2}$
observed.